

# KMX-3921

## HDR-Ready Modular Multiviewer

Multiformat multiviewer ensures future flexibility with built-in high dynamic range processing and 4K UHD display outputs for live productions.

With up to 48 multiviewer outputs per 4 RU frame, the KMX-3921 can be expanded up to 256 multiviewer outputs when connected to an upstream router.

Designed with live production operations in mind, the KMX-3921 offers the fastest processing on the market with only one field of latency. This fast multiviewer has also been optimized for reduction in space and power to meet the challenges of outside broadcast trucks. Ready for the future with 4K outputs for

UHD displays and high dynamic range/wide color gamut (HDR/WCG) support, the KMX-3921 modular design is scalable from 9 to 54 inputs, and 1 to 4 outputs using the same building block module.

Introducing HDR and WCG into a live production workflow adds a challenge for accurately viewing these sources on a multiviewer. The KMX-3921 provides HDR and WCG processing for HLG, PQ and S-Log3 HDR formats, and BT.2020 WCG. Each input is individually

configurable, which allows a mix and match of SDR and HDR sources, as well as different formats of HDR, on the same display.

With advanced probing and metadata extraction, such as SCTE 104, the KMX-3921 is also perfect for playout and transmission master control operations to ensure the quality of signal delivery.



## Key Features

### Fastest multiviewer

- Extreme low processing latency of 20 ms @ 50 Hz and 16.7 ms @ 59.94 Hz for live TV production requirements

### Unmatched image quality at any signal format

- 3G/HD/SD HDR ready inputs
- 4K UHD output available for higher resolution monitoring on 4K UHD displays
- Space-saving portrait display orientation capabilities with a simple software license activation, no additional hardware required

### Modular multiviewer design

- Each multiviewer expands up to 54 inputs
- Up to 24 KMX-3921 cards fit in a single 4 RU Densité® 3+ FR4 for up to 48 multiviewer outputs
- Up to four 3G/HD outputs or a single 4K UHD output per multiviewer
- Ethernet, LTC and reference distributed to all multiviewers within a Densité 3+ FR4 via frame controller
- Choice of rear panel SFP output options: SDI coaxial, HDMI or fiber

### Scalable multiviewer systems

- Scalable multiviewer system design up to 256 multiviewer outputs when connected to upstream router
- Seamless control across multiple multiviewers in a cluster

### High Dynamic Range (HDR) and Wide Color Gamut (WCG) processing

- Accurate monitoring experience of HDR/WCG sources on standard displays
  - Support for HLG, PQ and S-Log3 HDR format, and BT.2020 WCG
  - Input individually configurable for mix and match SDR and HDR sources, or different formats of HDR
- ### Ready for live production
- Low processing latency of 1 field for live TV production requirements
  - Tallies and multiple UMD levels to simplify workflow
  - Timecode and timers to keep production staff on cue
  - Wide range of switcher interface protocols for easy installation and configuration

### Advanced playout monitoring

- Extraction and display of SCTE 104 messages, including segmentation descriptors, for verifying transmission of ad insertion triggers and downstream processing signaling such as transcoders
- Main & Backup 50/50 split view widget allowing operators to rapidly catch main versus backup channel problems
- Zone-based black and freeze for excluding certain zones from signal probing, such as branding and lower third graphics
- Loudness metering, closed captions and teletext subtitle detection to ensure compliance with regulatory broadcasting requirements
- Dolby-E monitoring for silence detection without the need to decode the audio signal

## Specifications

### Video Inputs (9, 18, 27, 36 or 54)

#### SD-SDI:

- Signal: SMPTE ST 259-C (270 Mb/s), SMPTE ST 272
- Formats: 525i59.94 and 625i50
- Audio: SMPTE ST 274
- Return loss: >15 dB up to 270 MHz
- Alignment jitter (100 kHz): < 0.2 UI
- Timing jitter (10 Hz): < 1 UI
- Cable length: 250m (820 ft.) Belden 1694A
- Connector: DIN 1.0/2.3

#### HD-SDI:

- Signal: SMPTE ST 292-1 (1.485, 1.485/1.001 Gb/s)
- Formats: 720p29.97 720p30, 720p50, 720p59.94, 1080i50, 1080i59.94, 1080p23.98, 1080PsF23.98, 1080p24, 1080PsF24, 1080p25, 1080PsF25, 1080p29.97, 1080PsF29.97, 1080p30
- Audio: SMPTE ST 299
- Return loss: >15 dB up to 1.5 GHz
- Alignment jitter (100 kHz): < 0.2 UI
- Timing jitter (10 Hz): < 1 UI
- Cable length: 100m (328 ft.) Belden 1694A

#### 3G-SDI:

- Signal: SMPTE ST 424 (2.97, 2.97/1.001 Gb/s)
- Formats: 1080p50 (level A and B), 1080p59.94 (level A and B)
- Audio: SMPTE ST 299
- Return loss: > 15 dB up to 1.5 GHz, > 10 dB up to 3 GHz
- Alignment jitter (100 kHz): < 0.3 UI
- Timing jitter (10 Hz): < 2 UI
- Cable length: 100m (328 ft.) Belden 1694A

### MADI Inputs (1 to 4)

Input 9 of up to 4 cards can be configured for MADI input instead of SDI

**Signal:** AES10-2008

**Sampling frequency:** 48 kHz nominal, 64 channels, sync with video reference signal

**Cable length:** 300m (975 ft.) (Belden 8281 or Belden 1694A)

**Connector:** DIN 1.0/2.3

### Mosaic Outputs (1, 2 or 4)

The KMX-3921-9X2-4SR rear module is equipped with one (1) SFP slot, and the KMX-3921-18X4-4DR, the KMX-3921-27X4-4TR, the KMX-3921-36X4-4QR and the KMX-3921-54X4-4HR are equipped with two (2) SFP slots. Each slot can house one (1) of the SFP models listed below:

#### Processing Performance:

- Delay (referenced):
  - 16.7 ms @ 59.94 Hz
  - 20 ms @ 50 Hz
- Delay (free running):
  - Maximum 33 ms @ 59.94 Hz
  - Maximum 40 ms @ 50 Hz

#### HDMI SFP (optional):

- Number of outputs: 1 per SFP
- Connector: HDMI type D
- Signal: HDMI V1.4
- Format: 1920x1080p 50 Hz or 59.94 Hz

#### SDI Coaxial SFP (optional):

- Number of outputs: 2 per SFP
- Connector: DIN 1.0/2.3
- Signal HD: SMPTE ST 292-1 (1.485, 1.485/1.001 Gb/s)
- Signal 3G: SMPTE ST 424 (2.97, 2.97/1.001 Gb/s) Level A
- Formats: 1080p59.94, 1080p50, 1080i59.95, 1080i50

#### Fiber SFP (optional):

- Number of outputs: 2 per SFP
- Formats: 1080p59.94, 1080p50, 1080i59.95, 1080i50

(see SFP Optical Plug-in Cartridges webpage for full specifications)

#### Frame

Densité 3+ FR4 STD or Densité 3+ ADV  
Densité 3+ FR1 (single card 9x2 configuration only)

#### LTC Inputs (1 or 2\*)

Via Densité 3+ FR4 frame controller or REF-1801

#### Reference

Via Densité 3+ FR4 frame controller or REF-1801

#### GPIO

Device: Densité GPI-1501 (see webpage for full specifications)

#### Audio Monitoring

Embedded on mosaic outputs

\* Check for availability

## Ordering

### KMX-3921-9X1

9x1 scalable Kaleido multiviewer for Densité 3+ (SD/HD/3G SDI). Provides up to 9 PIPs over 1 display

### KMX-3921-9X2

9x2 scalable Kaleido multiviewer for Densité 3+ (SD/HD/3G SDI). Provides up to 9 PIPs over 2 displays, or 4 display when used with appropriate rear panel

### KMX-3921-9X2-3+SR

Single rear panel for optional SFP module. Suitable for Densité 3+ FR1, Densité 3+ FR4 STD or Densité 3+ ADV only

### KMX-3921-18X4-3+DR

Double rear panel with dual SFP slots. Required for expanding two KMX-3921 cards to 18x1, 18x2 or 18x4 multiviewer to provide up to 18 PIPs over 1, 2, or 4 displays. SDI, HDMI or fiber outputs from the rear panel require SFP selection (optional). Suitable for Densité 3+ FR4 STD or Densité 3+ ADV only

### KMX-3921-27X4-3+TR

Triple rear panel with dual SFP slots. Required for expanding three KMX-3921 cards to 27x1, 27x2 or 27x4 multiviewer to provide up to 27 PIPs over 1, 2, or 4 displays. SDI, HDMI or fiber outputs from the rear panel require SFP selection (optional). Suitable for Densité 3+ FR4 STD or Densité 3+ ADV only

### KMX-3921-36X4-3+QR

Quadruple rear panel with dual SFP slots. Required for expanding four KMX-3921 cards to a 36x1, 36x2 or 36x4 multiviewer to provide up to 36 PIPs over 1, 2, or 4 displays. SDI, HDMI or fiber outputs from the rear panel require SFP selection (optional). Suitable for Densité 3+ FR4 STD or Densité 3+ ADV only

### KMX-3921-54X4-3+HR

Six slot rear panel with dual SFP slots. Required for expanding four KMX-3921 cards to a 54x1, 54x2 or 54x4 multiviewer to provide up to 54 PIPs over 1, 2, or 4 displays. SDI, HDMI or fiber outputs from the rear panel require SFP selection (optional). Suitable for Densité 3+ FR4 STD or Densité 3+ ADV only

## Output Options

An output option is required for mosaic output from the rear panel

### SFP-3G-2OUT-L

Dual output HD/3G SDI long-reach coaxial SFP with DIN 1.0/2.3 connectors

### SFP-HDMI-OUT

Single output HDMI type D SFP with retention lock, cable not included

### HDMI-D-A-2

HDMI type D to A cable (2m) with retention lock

### SFP-T-S13-LC

Single Tx Fiber Module at 1310 nm with LC Connector

### SFP-TT-S13S13-LC

Dual Fiber Tx (output) cartridge at 1310 nm with LC/PC Connector

For more fiber options refer to CWDM SFP devices.

## Software Options

### KMX-3921-OPT-OP2

Second head output enable license for KMX-3921-9X1 (1/card)

### KMX-3921-OPT-CSX

CC/Subtitling and XDS data license for KMX-3921 (1/card)

### KMX-3921-OPT-DOLBY

License for extraction of Dolby-E Metadata for KMX-3921(1/card)

### KMX-3921-OPT-SCTE

License for extraction of SCTE 104 metadata for KMX-3921 (1/card)

### KMX-3921-OPT-ROT

Output rotation license for portrait display orientation for KMX-3921 (1/card)

### KMX-3921-OPT-LOUD

License for loudness monitoring for KMX-3921 (1/card)

### KMX-3921-OPT-HDR

License for HDR input processing for KMX-3921 (1/card)

Software options are required for every card in a multiple card configuration: 18x4, 27x4, 36x4 or 54x4

## Accessories

### KALEIDO-RCP2

Ethernet remote control panel and KM Gateway

### DXF-4K

Display output extender via fiber optic with SC connector. Distance: 1 km (3,280 ft.). Fiber optic cable: multimode 50 or 62.5/125 SC

### PSU-POE

Replacement power over Ethernet module

### KRCP-RK2

Kaleido-RCP2 rackmount bracket

### GPI-1501-TBA

GPI I/O terminal block adapter

### GPI-1501

GPI I/O module

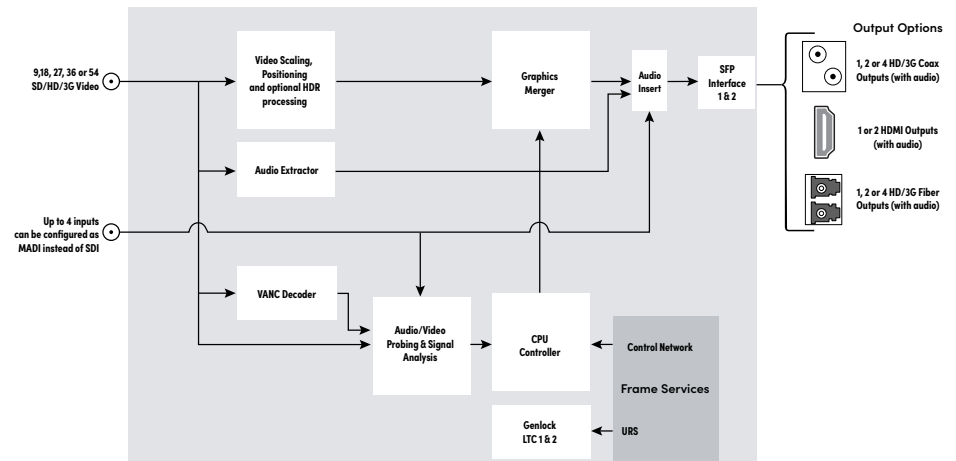

Functional Block Diagram

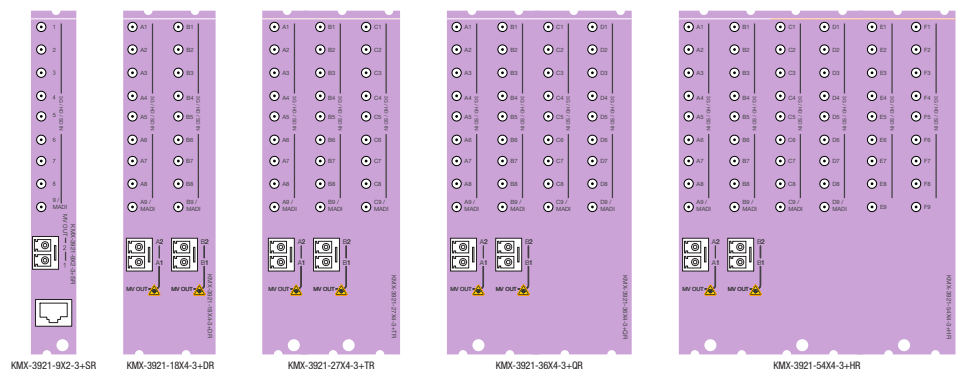

Rear Panels

# Scalable inputs and outputs

The number of inputs and outputs is scalable by combining two, three, four or six modules and a rear panel option that integrates all inputs to all outputs. Unlike cascading, the method of expansion used in the KMX-3921 does not add delay or latency to sources coming from different modules. 4K UHD output capability is available on the KMX-3921 in combinations of two or more cards.

## Scalable input & output capability using the same KMX-3921 building block.

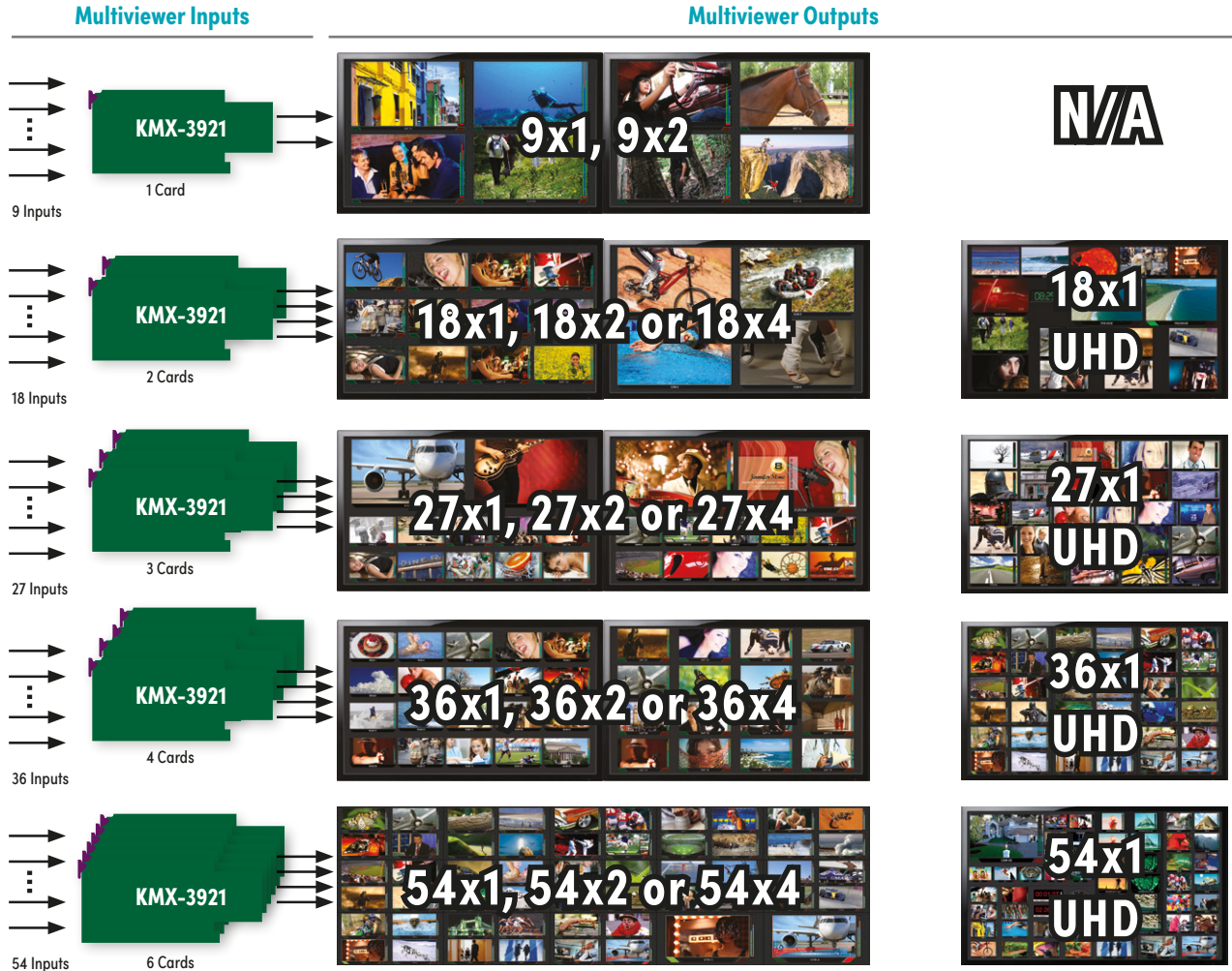

## Any Format



Signals of different aspect ratios can be displayed alongside each other, and the displays can be either landscape or portrait.

## Choice of multiviewer output connectivity options

Rear panels are available with one or two SFP slots. Each SFP slot can be equipped with one of the following SFP output options: SDI coaxial for broadcast monitors, HDMI for displays installed close to the multiviewer and fiber for extending the distance to the display. The HDMI output SFP option is designed with a latching mechanism to ensure the connection is solid in high vibration mobile environments such as outside broadcast trucks.

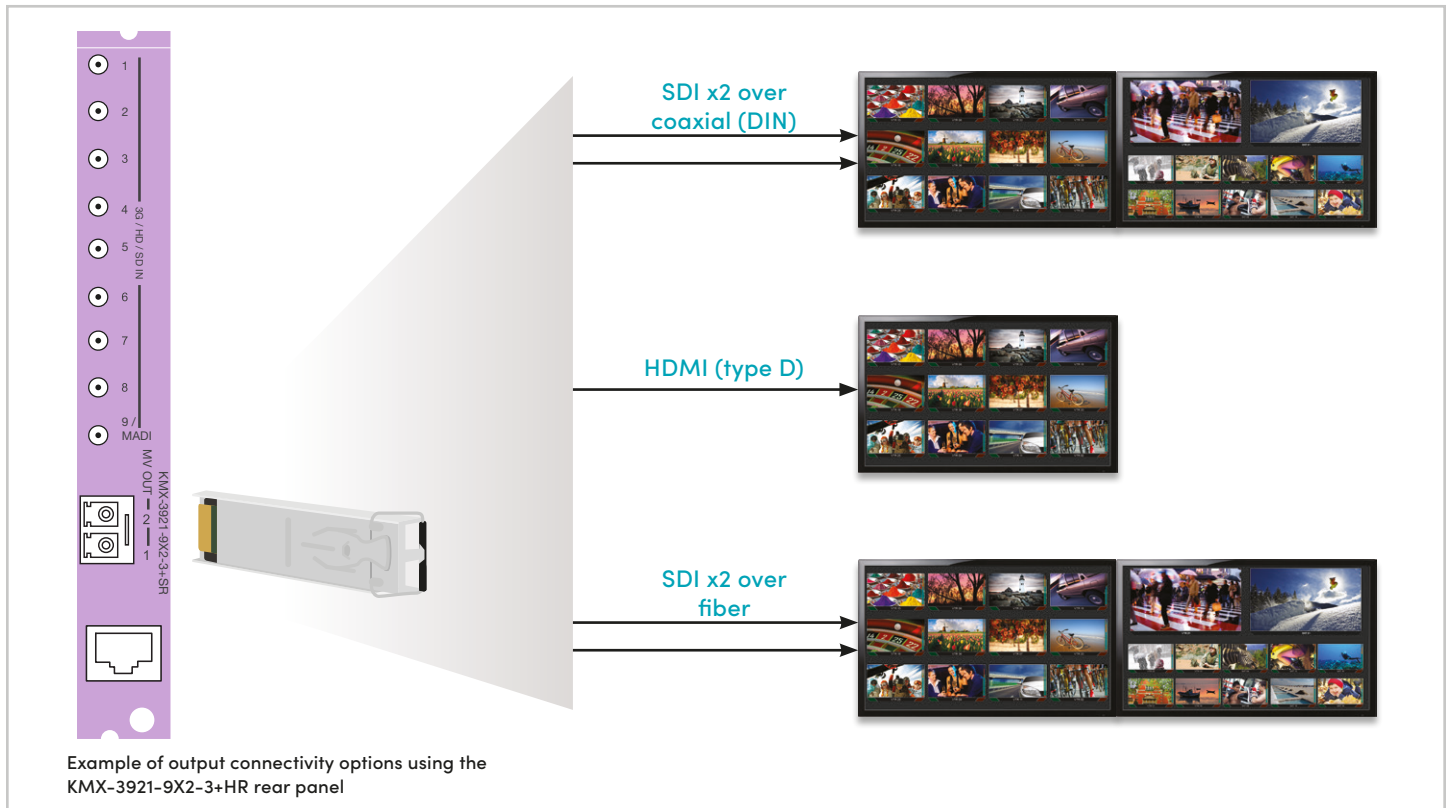

## All the features you need for live production

Providing fast, easy and simplified workflows, the KMX-3921 is ready to go with all the features required for production control rooms and outside broadcast trucks. This includes timecode displays, built-in timers, safe area markers, audio meters and tallies from the production switcher. The KMX-3921 also offers multiple levels of UMDs showing both static or dynamic information obtained from the control system, the production switcher or the tally management system. The fast processing time of one field makes it perfect for live production monitoring.

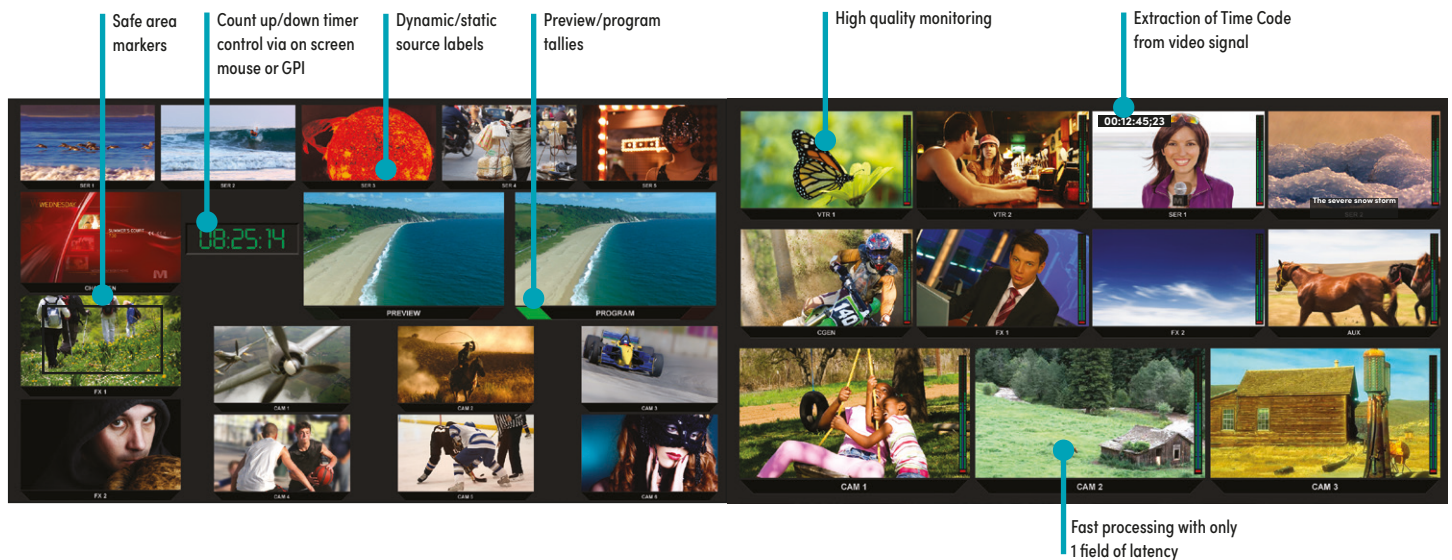

## High Dynamic Range (HDR) processing for accurate monitoring experience

Introducing high dynamic range (HDR) and wide color gamut (WGC) into a live production workflow adds a challenge for accurately viewing these sources on a multiviewer. Without an HDR capable multiviewer, the image will appear saturated, details are washed out, and colors are incorrectly reproduced. Adding HDR/WGC processing on the multiviewer provides the ability to correct this and provide a more accurate image, more HDR-like, on regular SDR displays. The KMX-3921 provides HDR and WGC processing for HLG, PQ and S-Log3 HDR format, and BT.2020 WCG. Each input is individually configurable which allows to mix and match SDR and HDR sources, as well as different format of HDR, on the same display.

Without HDR processing, HDR sources look "washed out" and saturated

With built-in HDR processing, HDR sources are mapped to the correct gamma and gamut

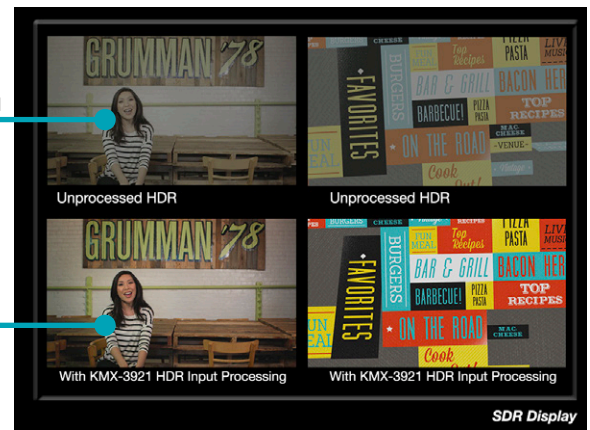

## Ready for playout master control and transmission

The KMX-3921 provides all of the advanced probing and metadata extraction for ensuring the quality of your on-air transmission, including specialized features like Dolby-E monitoring, zone-based black and freeze detection.

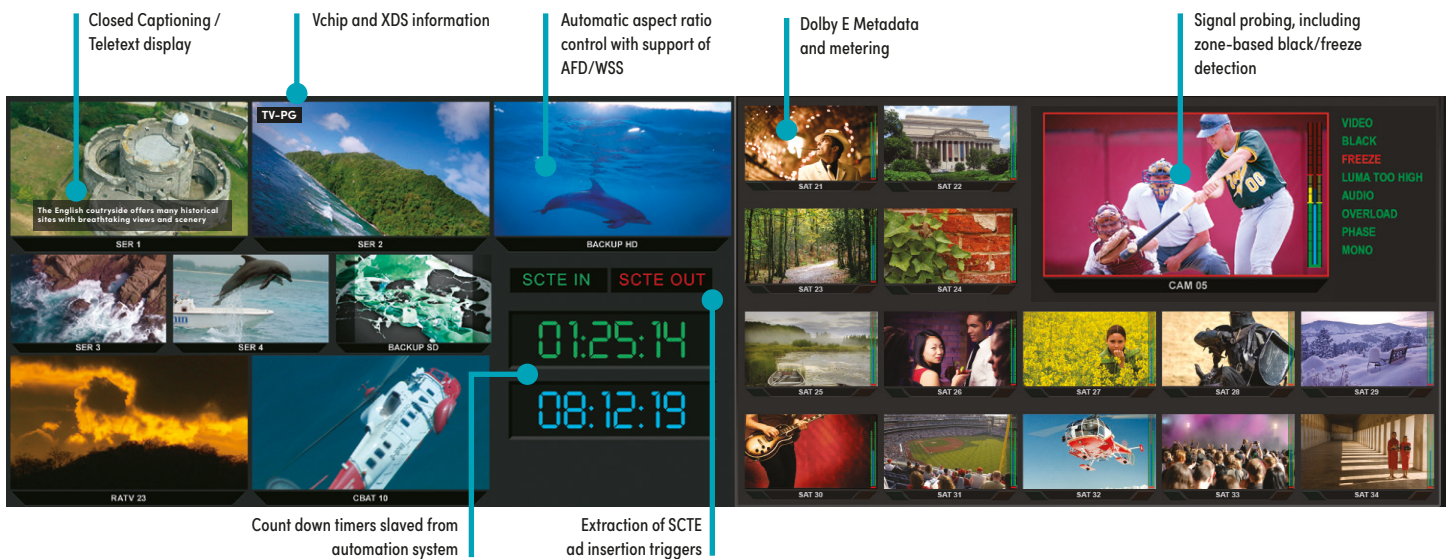

Count down timers slaved from automation system

Extraction of SCTE ad insertion triggers

## Optimized for Production Monitoring

With its unmatched space and energy efficiency, KMX-3921 is especially well suited to production monitoring in trucks. It also offers the picture quality and display flexibility demanded by the most critical operators. Its lightning fast processing removes the need for complex audio delay compensation, while satisfying the most discerning of directors.

The multiviewer system integrates tightly with the GV Orbit system with integrated audio processing, as well as Densité signal processing cards, and third-party production switchers. Control of a highly integrated system is simplified with the RCP-200 panel, which can operate the router and multiviewer, as well as signal processing and distribution cards.



### RCP-200 panel – controls

- Multiviewers
- Routing
- Signal processing
- Distribution



### Grass Valley or third-party switcher

- Tally updates
- Source and destination labels

3G/HD/SD Feeds



GV Orbit

Multiviewer outputs

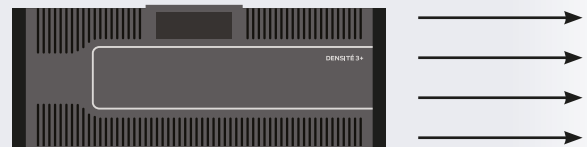

### Densité 3+ 4 RU frame – mix and match cards

- KMX-3921 multiviewer cards
- Signal processing cards
- Distribution cards

## Router Integration for Large Systems

The KMX-3921 offers seamless integration with GV Orbit and third-party routers to allow expansion up to 1,152 video inputs and 256 multiviewer outputs. By using the “Kaleido Cluster Feature,” multiple multiviewers can behave like a single virtual system from an operator’s perspective, with full layout flexibility.

For example, one GV Orbit system is integrated with 128 KMX-3921 multiviewer cards, housed in 6 Densité 3+ frames (24 RU total), to provide up to 256 multiviewer outputs. This system spans three independent control rooms, controlled by three operators.

Room 1: Audio



Room 2: Production control



Room 3: Replay

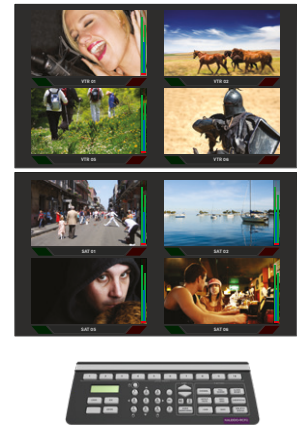

### 256 multiviewer outputs

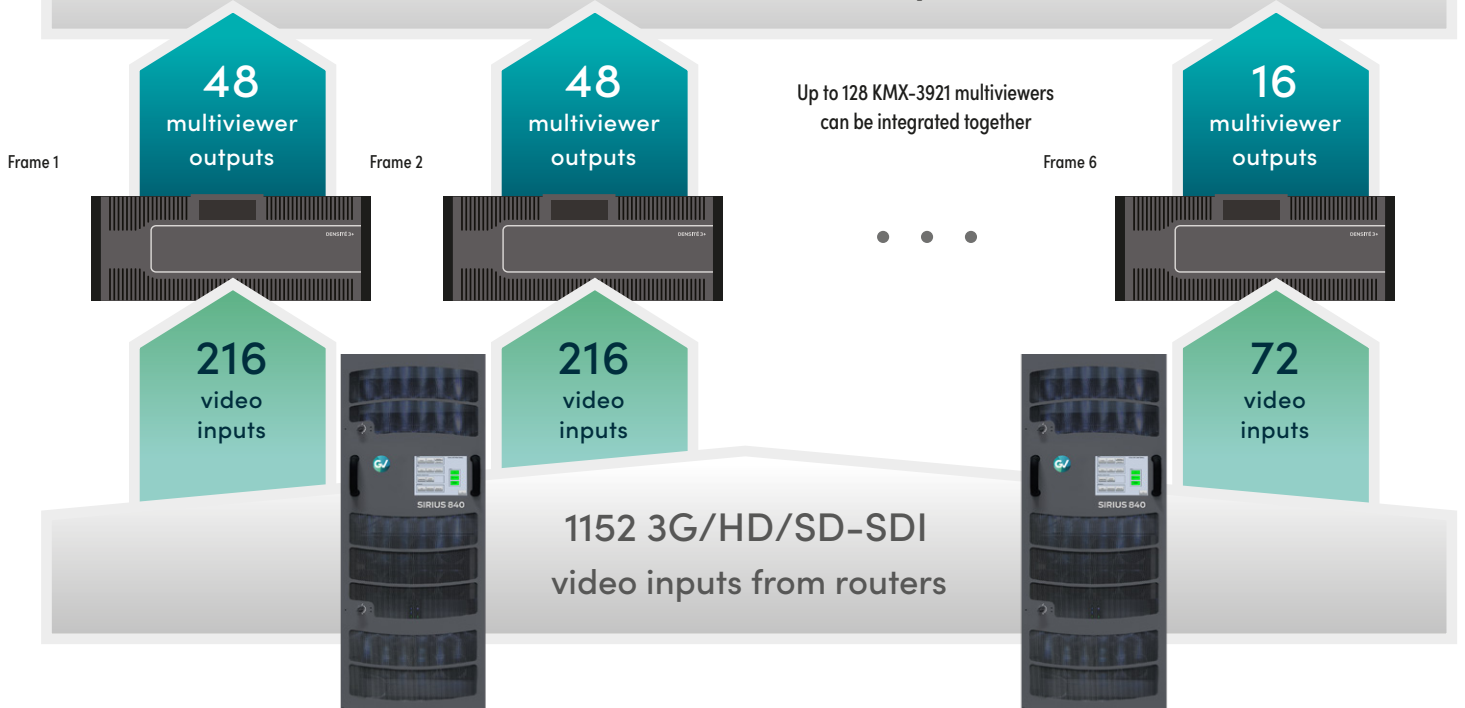

This product may be protected by one or more patents. For further information, please visit: [www.grassvalley.com/patents](http://www.grassvalley.com/patents)

DS-PUB-3-0679A-EN

Grass Valley®, GV®, GV Grass Valley®, and the Grass Valley logo are trademarks or registered trademarks of Grass Valley USA, LLC, or its affiliated companies in the United States and other jurisdictions. Grass Valley products listed above are trademarks or registered trademarks of Grass Valley USA, LLC or its affiliated companies, and other parties may also have trademark rights in other terms used herein. Copyright © 2018-2024 Grass Valley Canada. All rights reserved. Specifications subject to change without notice.

[www.grassvalley.com](http://www.grassvalley.com) Join the Conversation at GrassValleyLive on [Facebook](#), [X](#), [YouTube](#) and Grass Valley on [LinkedIn](#)